



Creating Exposure

LED LIGHT BOXES

 Van Raalte Displays



1851 TNG SWISS WATCHES THE NEW



COME
ABOARD

Produced to
your specific
requirements
within your
budget!



CHOOSE VAN RAALE LED DISPLAYS

Top quality and the highest reliability

Van Raalte Displays has specialised for more than 20 years in the development and production of Light-Boxes for indoor and outdoor use, including Tension Fabric and Snap Frame versions, all with LED illumination.

- Brilliant illumination of the visual
- Premium-brand LED components guaranteed for 3 years
- All of the lightboxes we make are CE marked
- Competitive prices

We have the perfect lightbox for every budget, with a choice of

- Different levels of brightness
- Profiles of different widths
- Displays of different sizes
- Single or double-sided
- Free-standing, suspended or wall-mounted

Our complete range of aluminium profiles, LED components and accessories will meet all of your needs and requirements - including your budget.



ALREADY WITH US?

GET 4GB DATA FOR JUST £22.99 A MONTH ON SIM ONLY

ENJOY ALL THIS WITH EE



WELCOME

TO THE UK'S BIGGEST, FASTEST AND MOST RELIABLE NETWORK

RootMetrics UK network performance award winner

Best Buy Watch?

MOBILE CHOICE AWARDS 2013

WHAT MOBILE Awards 2013

MOBILE CHOICE AWARDS 2013 BEST IN MOBILE NETWORKS

TRADING AWARDS AWARDS

FLATLIGHT LED

Snap frame with LED illumination

Produced to your specific requirements within your budget!

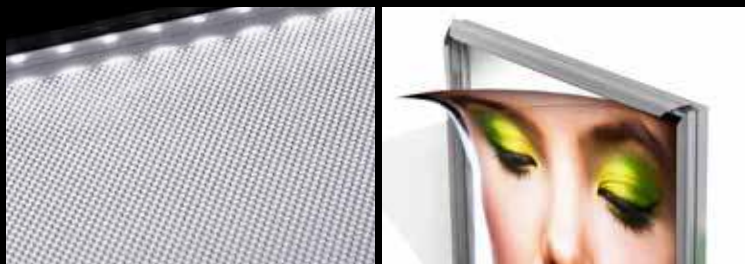

Effective use of the Edge-Light principle: Visual: backlit poster a lasered acrylic panel with LED strips

The VR Flatlight is an ultra-flat lightbox that includes both the popular snapframe system and the Edge-Light principle: the acrylic panel is lit by LED strips on one or both sides. The unique pattern lasered on the acrylic panel ensures even illumination of the backlit poster.

Benefits

- Ultra-flat lightbox: SS 25 mm deep / DS 35 mm deep
- Brilliant illumination of the visual
- Very low energy consumption

Technical specifications

- Back plate: Forex
- Thickness of the lasered acrylic panel: 4, 6 or 8 mm (depending on the model)
- Type of LED: SMD 3014 Osram or Samsung
- Light colour: 6000K
- Dimensions: Available in any size up to 1700 x 3000 mm
- LED components are guaranteed for 3 years

Designs

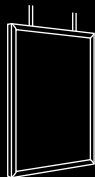

SS and DS suspended

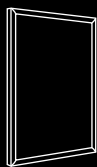

SD wall mounted

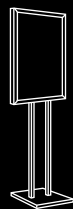

SS and DS free-standing



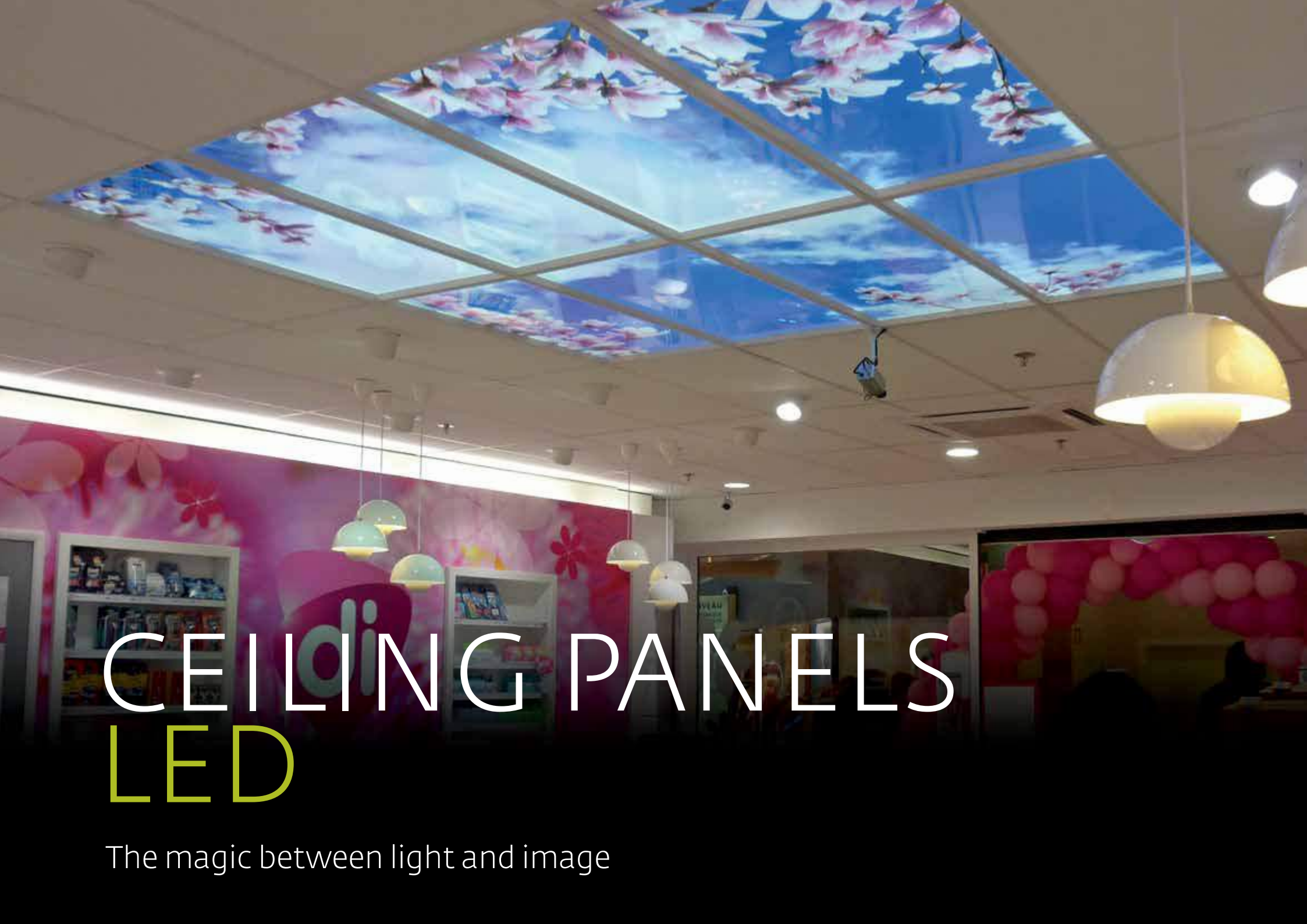

CEILING PANELS LED

The magic between light and image



Effective use of the Edge-Light principle:
a lasered acrylic panel with LED strips

LED ceiling panels create a unique sense of daylight. An easy way to fill an uninviting space with a welcoming atmosphere. These ceiling panels are used in hospitals, waiting rooms, showrooms, meeting rooms, conference centres, canteens, shops, etc.

Benefits

- Creation of a unique ambiance
- Plug and Play: the panels are very easy to install
- Compatible with all ceiling systems

Technical specifications

- Thickness of the lasered panel: 5 mm
- Type of LED: SMD 3014 Osram
- Light colour: 6000K
- Dimensions: Available in any size up to 1500 x 3000 mm
- LED components are guaranteed for 3 years

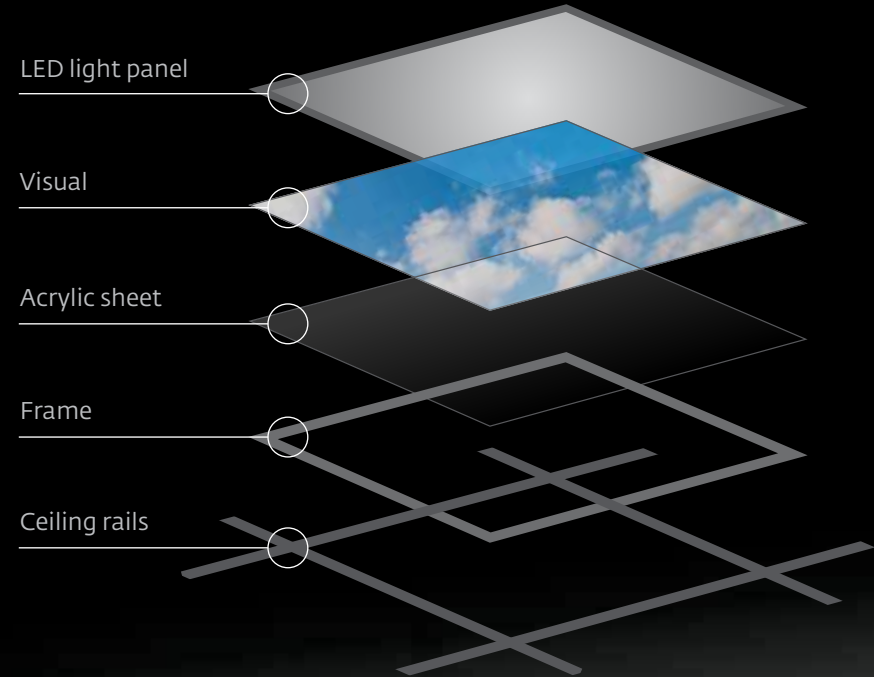



WINDOW-FRAME LED

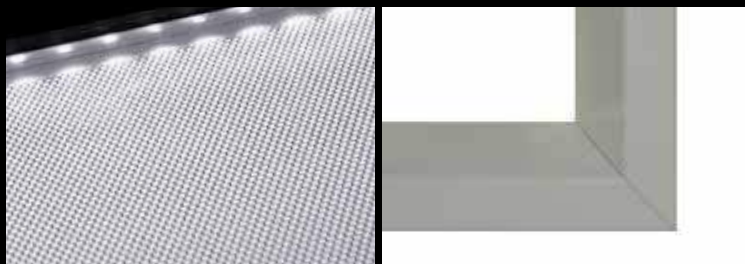

Effective use of the Edge-Light principle: Window-Frame profile
a lasered acrylic panel with LED strips

The VR Window-Frame LED is installed on a wall. The combined effect of the frame and the visual creates the illusion of a real window.

Benefits

- Creation of a unique ambiance
- Brilliant illumination of the visual
- Very low energy consumption

Technical specifications

- Thickness of the lasered panel: 6mm
- Type of LED: SMD 3014 Osram
- Light colour: 6000K
- Dimensions: Available in any size up to 1500 x 3000 mm
- LED components are guaranteed for 3 years

Designs

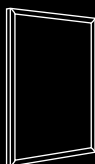

Wall mounted



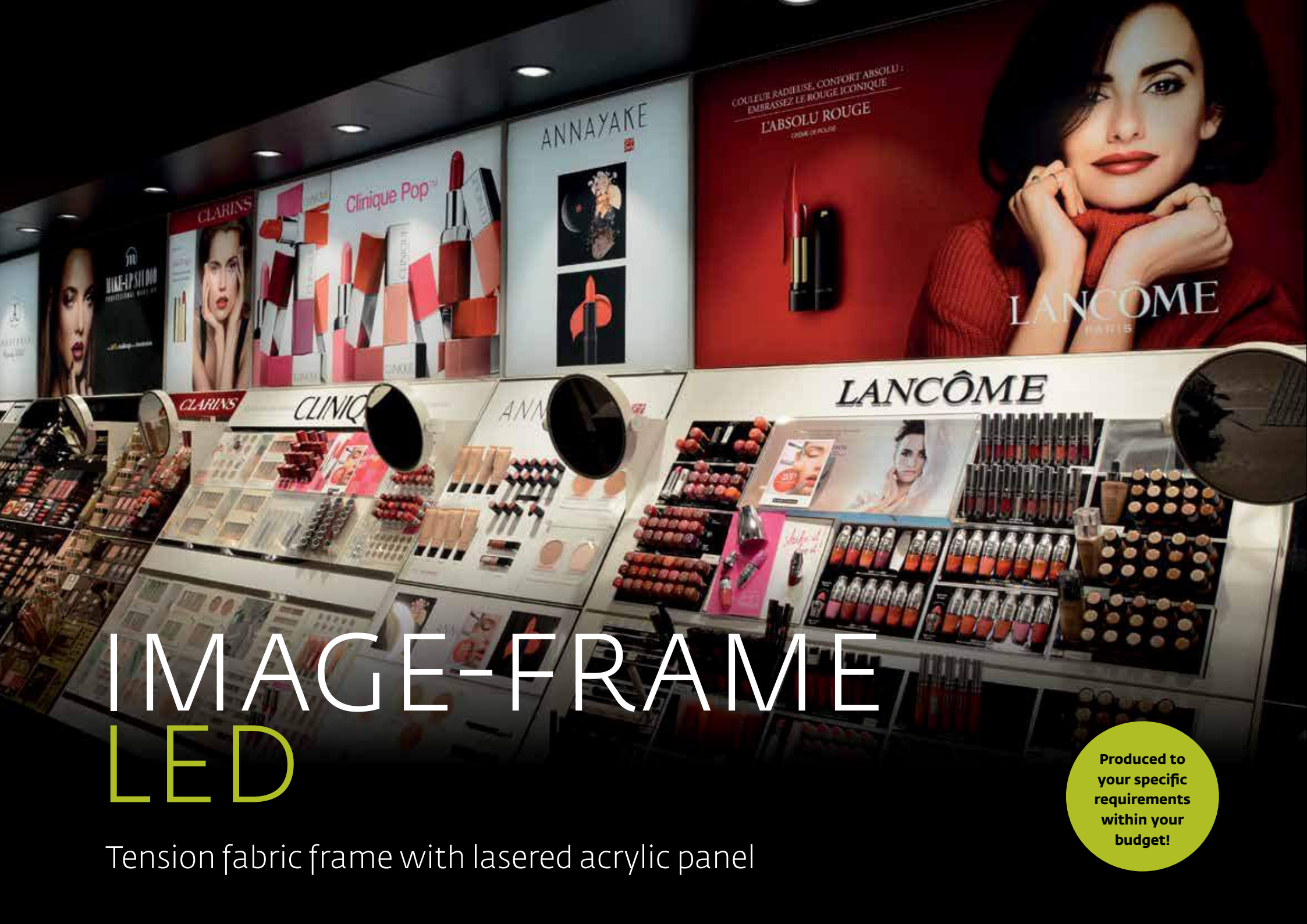

IMAGE-FRAME LED

Tension fabric frame with lasered acrylic panel

Produced to
your specific
requirements
within your
budget!



Effective use of the Edge-Light principle: Ultra-flat lightbox
a lasered acrylic panel with LED strips

The VR Image-Frame LED makes effective use of Edge-Light principle: the lasered acrylic panel is lit by LED strips on one or both sides. The unique pattern lasered on the acrylic panel ensures brilliant and even illumination of the visual.

Benefits

- Available as double and single-sided displays
- Ultra-flat lightbox SS 45mm deep DS 55mm deep
- Brilliant illumination of the visual
- Very low energy consumption

Technical specifications

- Back plate: Forex
- Thickness of the lasered acrylic panel: 4, 6 or 8 mm (depending on the model)
- Type of LED: SMD 3014 Osram or Samsung
- Light colour: 6000K
- Dimensions: Available in any size up to 1700 x 5000 mm
- LED components are guaranteed for 3 years

Designs

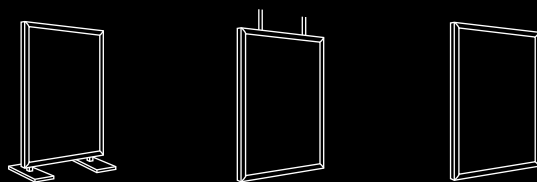

DS free-standing

SS and DS suspended

SS wall mounted

T +31 (0)71 561 10 40 | www.van-raalte.com





IMAGE-FRAME LED BACKLIGHT

Tension fabric frame with backlight

Produced to
your specific
requirements
within your
budget!



Flexible LED strip

LED curtain

The VR Image-Frame LED Backlight is available as a single-sided display in a range of depths. The high light output makes this lightbox ideal for window displays.

Benefits

- Very high light output
- Brilliant illumination of the visual
- Choice of 3 depths: 50, 65 and 90 mm
- Available in any size

Technische specificaties

- Back plate: Dibond
- Type of LED: Epistar with 160° lens
- Light colour: 6000K
- LED components are guaranteed for 3 years

Designs

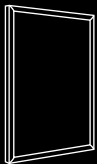

SS wall mounted





IMAGE-FRAME POWER LED

Tension fabric frame with Power LEDS

Produced to
your specific
requirements
within your
budget!



Fitted with Power LEDs for large displays

Fitted with Power LEDs for narrow lightboxes

The VR Image-Frame Power LED is available in a wide range of versions. The size and depth of the display, and the desired light output, determine which type of Power LED is used and whether LEDs are installed on one or both sides.

Benefits

- Available in a wide range of versions
- Brilliant illumination of the printed fabric
- Can be produced in ultra-large sizes
- The lightbox is delivered in parts and is easy to assemble on site

Technical specifications

- Single-sided models 80, 90 and 120 mm deep
Double-sided models 100 and 200 mm deep
- Type of LED: Samsung or Osram
- Dimensions: Available in any length up to a max. height of 3000 mm
- LED components are guaranteed for 3 years

Designs

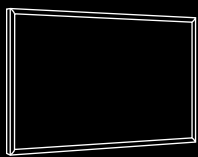

SS wall mounted

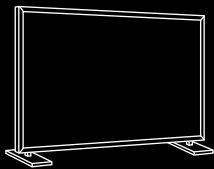

SS and DS free-standing



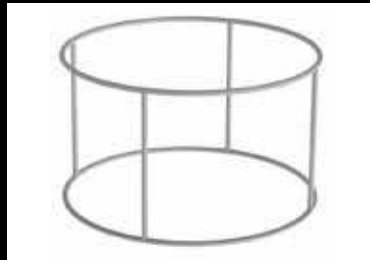

IMAGE-FRAME LED SPECIALS





Available as curved displays



Available as circular displays

Curved and circular displays

LED-backlit Tension Fabric Frame displays can be produced as curved displays. Different methods can be used to illuminate the printed fabric.



Cube corner piece



Cube corner piece with profile

As a cube

LED-backlit Tension Fabric Frame displays can be constructed as a cube. Different methods can be used to illuminate the printed fabric.





FRONTLIGHT LED

For outdoor use

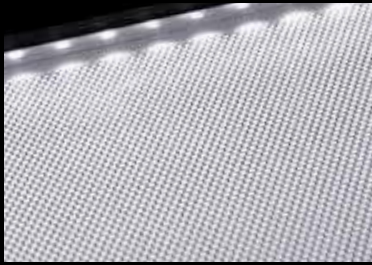

Effective use of the Edge-Light principle:
a lasered acrylic panel with LED strips

Deep energy-guzzling recessed lightboxes are a thing of the past. The VR Frontlight LED is an ultra-flat lightbox (30mm) for outdoor use that ensures even illumination of text and logo without dark areas.

Benefits

- Ultra flat (30 mm) facade lightbox
- Brilliant illumination of the advertisement
- Energy efficient
- Available as double and single-sided displays

Technical specifications

- Thickness of the lasered acrylic panel: 6 mm
- Type of LED: SMD 3014 Samsung IP67
- Light colour: 6000K
- Dimensions: Available in any size up to 800 x 3000 mm
- LED components are guaranteed for 3 years

Designs

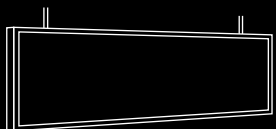

SS and DS suspended



SS wall mounted

Top profile

Corner pieces

LED strip

Light panel

Front sheet

Side profile

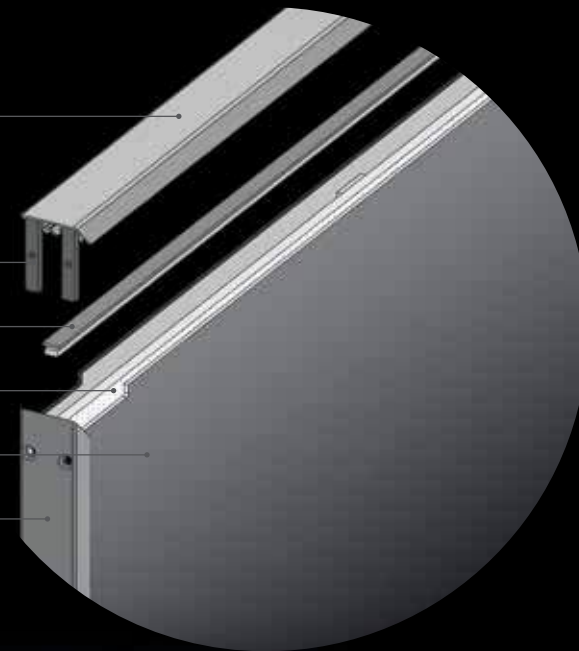



FLATLIGHT LED LOCKABLE

For outdoor use

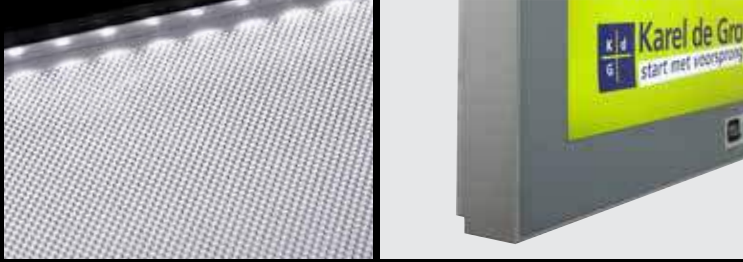

Effective use of the Edge-Light principle: Overall depth just 60mm
 a lasered acrylic panel with LED strips

The VR Flatlight Lockable is a high quality ultra-flat LED lightbox for outdoor use. The Edge-Light principle ensures even illumination of the poster without dark areas.

Benefits

- High quality presentation
- Door fitted with durable gas springs
- Energy efficient
- Brilliant illumination of the visual poster

Technical specifications

- Welded aluminium construction
- Door fitted with 5mm safety glass
- Type of LED: SMD 3014 Osram or Samsung IP 67
- Light colour: 6000K
- Dimensions: Available in any size up to 1180 x 1750 mm
- Minimum purchase: 10 displays
- Guaranteed for 3 years

Designs

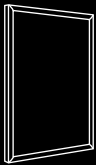

SS wall mounted

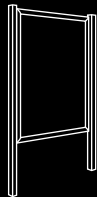

SS and DS free-standing

T +31 (0)71 561 10 40 | www.van-raalte.com





STORESTOPPER LED

Moveable illuminated pavement sign with battery



Effective use of the Edge-Light principle: a lasered acrylic panel with LED strips

Double-sided Tension Fabric Frame display

The VR StoreStopper LED, with its double-sided backlit Tension Fabric Frame display brings a new dimension to pavement signs. The rechargeable battery built into the base has sufficient capacity to illuminate the sign for +/- 12 hours.

Benefits

- Wireless double-sided illuminated pavement sign. Power supplied by a rechargeable battery built into the base
- Very high light output
- Double-sided Tension Fabric Frame display

Technical specifications

- Sizes: A1 and 700 x 1000 mm
- Type of LED: SMD 3014 Samsung IP 67
- Light colour: 6000K
- Thickness of the lasered acrylic panel: 8 mm
- Operating capacity: +/- 12 hours
- Guaranteed for 1 year



Van Raalte delivery program

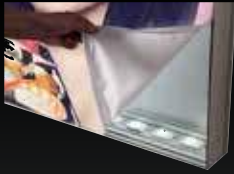

Tension fabric frames with and without LED



LED light boxes for indoor and outdoor use



Digital signage



Pavement signs



Standard products



Custom built displays